

MITEL

3300 | IP Communications Platform

MITEL 5330 IP and 5340 IP Phones
User Guide

 MITEL | it's about **YOU**

NOTICE

The information contained in this document is believed to be accurate in all respects but is not warranted by Mitel Networks™ Corporation (MITEL®). The information is subject to change without notice and should not be construed in any way as a commitment by Mitel or any of its affiliates or subsidiaries. Mitel and its affiliates and subsidiaries assume no responsibility for any errors or omissions in this document. Revisions of this document or new editions of it may be issued to incorporate such changes.

No part of this document can be reproduced or transmitted in any form or by any means - electronic or mechanical - for any purpose without written permission from Mitel Networks Corporation.

TRADEMARKS (example only)

Mitel and Speak@Ease are trademarks of Mitel Networks Corporation.

Windows and Microsoft are trademarks of Microsoft Corporation.

Other product names mentioned in this document may be trademarks of their respective companies and are hereby acknowledged.

Mitel 5330 IP and 5340 IP Phones - User Guide
September 2006

®,™ Trademark of Mitel Networks Corporation
© Copyright 2006, Mitel Networks Corporation
All rights reserved

ABOUT YOUR PHONE	7
Elements of Your Phone	8
Ring/Message indicators	10
For Users on Resilient 3300 ICP Systems	10
Mitel Line Interface Module	10
TIPS FOR YOUR COMFORT AND SAFETY	11
Don't cradle the handset!	11
Protect your hearing	11
Adjust the viewing angle	11
USING YOUR DEFAULT PHONE WINDOW AND KEYS.....	12
Getting Started with Your Phone	12
USING YOUR PHONE APPLICATIONS	14
Using the Settings Application	15
Getting Help.....	16
Tips for Setting up your Phone	16
CUSTOMIZING YOUR PHONE	17
Specify User Information.....	17
Specify Language.....	18
Specify Display Brightness and Contrast	18
Specify Audio Feedback Options	19
Specify Text Size	19
Specify Call Notification Behavior.....	20
Adjust the Ringer	20
Enable a Screen Saver (5340 only).....	21
Program Receipt of External Messaging	22
Enable URL Displays on your Phone	22
Enable PC Connectivity	22

USING THE PC COMPANION APPLICATION	23
About the PC Companion Application	23
Configuring the PC Companion Application on Your Phone	23
Installing the PC Companion Application	23
Opening the PC Companion Application	24
Programming Feature Keys Using the PC Companion Application	25
Clearing, Editing or Copying Key Programming	26
PROGRAMING FEATURES ON YOUR KEYS	27
Tips on Programming Features	27
Program Feature Keys Using the Settings Application	30
Clear Programming from a Key	31
SETTING UP YOUR CONTACT LIST (5340 ONLY)	32
Adding names to your contact list	32
Editing information in your contact list	32
MAKING AND ANSWERING CALLS	33
Dial from your People Application (5340 IP Phone only)	33
Phone Book	33
Answer a call	34
End a call	34
Redial	34
Redial - Saved Number	34
Handsfree Operation	35
Auto-Answer	36
Using the Analog line	36
CALL HANDLING	37
Hold	37
Mute	37
Transfer	38

Conference	38
Conference Split.....	38
Add Held.....	39
Swap.....	39
Call Forwarding	39
USING OTHER FEATURES.....	42
Account Codes	42
ACD	42
Attendant Call Hold - Remote Retrieve.....	43
Callback	43
Call Forward - Remote (I'm Here)	43
Call Forward - End Chaining.....	44
Call Forward - Forced.....	44
Call Forward - Override.....	45
Call History.....	45
Call Park.....	46
Call Pickup.....	47
Campon	47
Direct Paging	47
Do Not Disturb.....	50
Emergency Calls	50
Group Listen	52
Group Paging / Meet Me Answer	52
Headset Operation.....	53
Hot Desking	54
Hot Desk Remote Logout	54
Hot Desk - PIN Change	55
Make Busy	55

Message Waiting Indicator	56
Messaging - Advisory	56
Messaging - Callback.....	56
Messaging - Cancel Callback.....	58
Messaging - Cancel All Callbacks	58
Music.....	58
Night Answer	58
Override (Intrude)	59
Paging	59
Record a Call.....	59
Reminder.....	60
Speak@Ease.....	61
Speed Call	61
Tag Call.....	61
Trunk Flash	62
USING YOUR PHONE WITH THE 5310 IP CONFERENCE UNIT	63
Access the Conference Controller	63
Turn the conference unit on and off.....	63
Adjust the conference unit volume	63
Place the conference unit in Presentation mode.....	63
Exit the conference controller	63
Mute the conference unit	64
USING THE LINE INTERFACE MODULE	64
Making and Answering Calls Using the Analog key.....	64
Making and Answering Calls Using the Failover Mode	65

ABOUT YOUR PHONE

The Mitel® 5330 and 5340 IP Phones are full-feature, dual port, dual mode enterprise-class telephones that provide voice communication over an IP network. They both feature a large graphics display (160 x 320) and self-labeling keys. The 5330 IP Phone offers 24 programmable multi-function keys, and the 5340 IP Phone offers 48 programmable multi-function keys for one-touch feature access. Both phones provide ten fixed feature keys for convenient access to features such as Conferencing, Redial, and many customizable user settings as well as navigational keys to access various screens and application layers. The 5330 and 5340 IP Phones also feature a PC Companion application, which is a PC-based desktop programming tool, that allows you to easily configure your phone from your Personal Computer (PC).

The 5330 and 5340 IP Phones support Mitel Call Control (MiNet) protocol and session initiated protocols (SIP). Both phones support the Line Interface Module and 5310 IP Conference Unit. Additionally, they support Hot Desking and Clustered Hot Desking as well as Resiliency. The 5330/5340 phones are ideal for executives and managers, and can be used as an ACD Agent or Supervisor Phone, as well as a Teleworker Phone.



NN0220

The 5330 IP Phone









NN0218

The 5340 IP Phone

Elements of Your Phone

Feature	Function
1) Display	Provides a large, high-resolution viewing area that assists you in selecting and using phone features.
2) Ring/Message Indicator	Flashes to signal an incoming call and to indicate a message waiting in your voice mailbox.
3) Volume, Speaker and Mute Controls	Provide the following audio control capability: <ul style="list-style-type: none"> • (UP) and (DOWN) provide volume control for the ringer, handset, and handsfree speakers. • (SPEAKER) enables and disables Handsfree mode.

Elements of Your Phone

Feature	Function
	<ul style="list-style-type: none"> •  (MUTE) enables Mute, which allows you to temporarily turn your phone's handset, headset or handsfree microphone off during a call.
4) Fixed Function Keys	<p>Give you access to the following phone functions:</p> <ul style="list-style-type: none"> •  (SETTINGS) : provides access to menus for your phone's additional features. •  (CANCEL) : ends a call when pressed during the call, and, when you are programming the phone, eliminates any input and returns to the previous menu level. •  (REDIAL) : calls the last number dialed. •  (HOLD) : places the current call on hold. •  (TRANS/CONF) : initiates a call transfer or establishes a three-party conference call. •  (MESSAGE) : provides access to your voice mailbox and flashes to notify you of messages waiting in your voice mailbox. Note : The Ring/Message indicator also flashes when messages are waiting.
5) Keypad	Use to dial.
6) Navigation Page Keys	Use to display additional pages of information. The 5330 has two page navigation keys: Back and Next. The 5340 has three page navigation keys: Back, Next, and Home.
7) Programmable Feature Keys and Softkeys.	Provides 24 (on the 5330) and 48 (on the 5340) self-labeling keys that can be programmed as speed call keys, fixed function keys, hard keys, applications, or line appearance keys, according to your communication needs. On your home page, the bottom right feature key is always your Prime Line key on a 5340 IP Phone; and the bottom left feature key is always your Prime Line key on the 5330 IP Phone. The top three keys are softkeys.
8) Handsfree Speaker	Provides sound for Handsfree calls and background music.
9) Handset	Use for handset calls. If you are in headset or handsfree mode, you do not need to use the handset.

Ring/Message indicators

When indicator is it means that

Flashing rapidly	Your phone is ringing
Flashing slowly	A message or callback message is waiting at your phone
On	Your phone is ringing another phone
Off	Your phone is idle, or you are on a call

For Users on Resilient 3300 ICP Systems

If during a call, you hear a beep repeated every 20 seconds it means that your phone is switching to a secondary 3300 ICP system. The call continues and there is a change in the operation of some keys and features on your phone. Normal operation resumes when your phone switches back to the primary system. If your phone is idle and switched to the secondary system, you'll see a flashing rectangle on the display. The rectangle remains until the switch to the primary system is complete.

If the phone fails over to the secondary ICP, you have access to your mailbox on the secondary ICP only if a mailbox has been programmed for you by your Administrator.

Notes:

- The mailbox on the secondary ICP will not contain the same messages as the mailboxes on the primary ICP. Any preferences that are voice mail related are not carried from the primary ICP to the secondary ICP. These preferences must be set on both ICPs.
- The *People* and *Settings* applications do not support resiliency. Your logs, contact information and any Settings on the primary ICP will not be carried from the primary ICP to the secondary ICP.

Mitel Line Interface Module

The Line Interface module is an optional device that adds an analog phone line (POTS) capability to your phone. If Emergency Call Routing is not programmed on your 3300 ICP, you must use the Line Interface Module to dial emergency calls. For more information on emergency number dialing, refer to *Emergency Calls*. If you have a Line Interface Module connected to your phone, all programming of the Line Interface Module, except the Analog Key, is done by the Installer when your phone is installed. For more information, refer to [Programming Features on Your Keys](#) and [Using the Line Interface Module](#).

TIPS FOR YOUR COMFORT AND SAFETY

Don't cradle the handset!

Prolonged use of the handset can lead to neck, shoulder, or back discomfort, especially if you cradle the handset between your ear and shoulder. If you use your phone a lot, you may find it more comfortable to use a headset. See the section on headset usage elsewhere in this guide for more information.

Protect your hearing

Your phone has a control for adjusting the volume of the handset receiver or headset. Because continuous exposure to loud sounds can contribute to hearing loss, keep the volume at a moderate level.

Adjust the viewing angle

The stand built into your phone tilts to give you a better view of the keys.

To tilt your telephone for better viewing:

1. Turn the phone so that the front faces away from you.
2. Hold the base unit firmly and press the release tabs on the sides of the stand to detach the base unit.
3. Hinge the hooks of the base unit into the notches on the back of the phone and snap into place as follows:
 - a) For a high-angle mount, hinge the two lower hooks into the bottom set of notches and snap the two upper hooks into the middle set of notches.
 - b) For a low-angle mount, hinge the two lower hooks into the middle set of notches and snap the two upper hooks into the top set of notches.

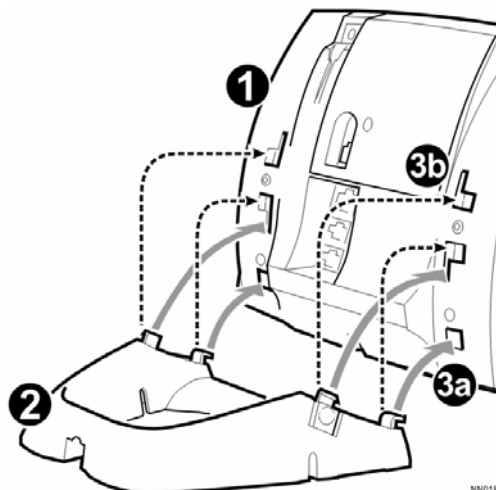

USING YOUR DEFAULT PHONE WINDOW AND KEYS

The 5340 and 5330 IP Phone default phone windows and keys are shown and described below. The Phone window provides access to programmable keys and the main phone interface.

Getting Started with Your Phone



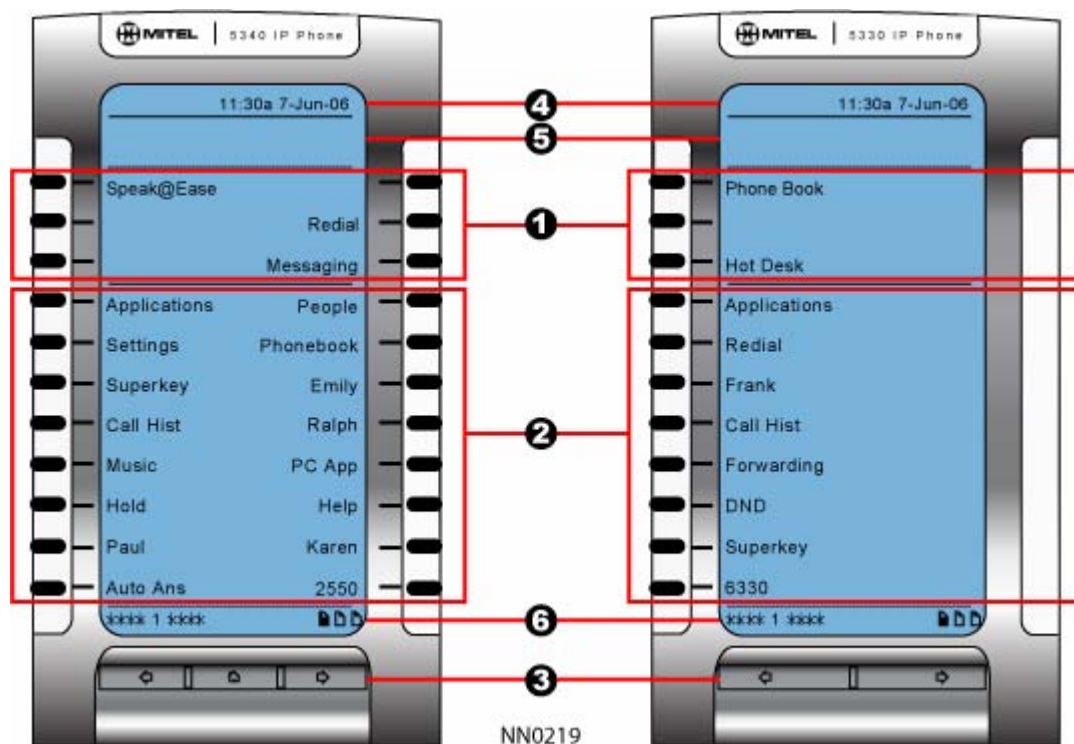

When you receive your phone, you need to program features and applications. An **Applications** key is programmed and appears on the upper left side of the display (see figure below).

Press **Applications** to program your phone's settings, your contact list using **People** (5340 IP Phone), call forwarding and so forth. See [Using Your Phone Applications](#).



5340 and 5330 IP Phone Window

5340 and 5330 IP Phone Default Window and Keys

Feature	Function
1) Softkeys	Allow you to access specific call control features, which are context sensitive. Non-programmable feature keys, which are specific to the application or state of the set. The 5330 provides three softkeys and the 5340 provides six softkeys.
2) Programmable Keys	Launch specific call control features. Use the <i>Settings</i> application or the PC Companion application to program these keys. The 5340 provides 16 programmable keys per page (a maximum of 47 programmable keys plus 1 prime line key). The 5330 provides 8 per page (a maximum of 23 programmable keys plus 1 prime line key). For instructions on programming the keys, see Programming Features on Your Keys .
3) Navigation Page Keys	Display additional pages of information. The 5330 has two page navigation keys: Back and Next, while the 5340 has three page navigation keys: Back, Next, and Home.
4) Status Line	Displays time, date, and icons indicating feature states as follows: <ul style="list-style-type: none"> • Message Waiting () - Indicates new voice mail. • Headset () - Indicates that the phone is in headset mode. • DND () - Indicates DND (Do not disturb) mode. • Logged in as () - Indicates that a hot desk user is logged in. • Conference Unit () - Indicates that the Conference Unit is connected and turned on.
5) Information Area	Provides prompts in most phone applications. Content changes based on the application.
6) Footer	Shows context and summary information based on information in the Programmable Keys area, such as Page Indicators, numbers of items, and so forth.

USING YOUR PHONE APPLICATIONS

Your 5330 and 5340 IP Phones provide applications that simplify the use of your phone. *Applications* provides access to all the phone's applications.

To open the *Applications* window, press **Applications** in the default Phone window. The *Applications* home window gives the current status of your phone's applications.

To open an application, press the key beside the application name:

- **People (5340 IP Phone only):** Use the *People* application to add, delete and edit contact names and numbers. You can also dial anyone on your contact list from the *People* application. The *People* window displays up to eight contacts per page, ordered alphabetically by last name. For information on using the *People* application, refer to [Setting Up Your Contact List](#) and [Dial From Your People Application](#).
- **Call Forwarding:** Use the *Call Forwarding* application to create Call Forward profiles that identify where to send your incoming calls. The Call Forwarding window shows a list of your Call Forwarding profiles and indicates which one is active. See [Call Forward](#) for more information on how to add, edit, delete, and activate Call Forwarding profiles.
- **Conference Unit:** Use the *Conference Unit* application to control the 5310 IP Conference Unit. Use this application to turn the conference unit off or on, to adjust the volume, or to put the conference unit into Presentation mode. You can only run one Conference Controller session at a time. The *Conference Unit* application is available only when your phone is connected to a 5310 Conference Unit. See [Using Your Phone with the 5310 Conference Unit](#) for more information.
- **Settings:** Use the *Settings* application to display and quickly change your phone's current communications settings. See [Using the Settings Application](#) for more information.
- **Launch PC Application:** Provides a launch point to the PC Companion Application. See [Using the PC Companion Application](#) for more information.
- **Help:** Provides access to Launch PC Help and Quick Help and displays a list of the key icons.
- **Call Info:** Use the *Call Info* application to display caller information on your phone's prime line. Call Info appears automatically on incoming calls if the Call Notification—Display Call Info Setting is enabled and Call Info is available.

You can press the programmed application key from the default Phone Window. For information on programming keys, see [Programming Features On Your Keys](#).

Using the Settings Application

The *Settings* application provides a single location to access all your phone settings. You can also launch the *Settings* application by pressing the **Settings** fixed function key .

The *Settings* window provides access to the *Settings* application. Select these options to access a window where you can view and configure settings for your phone.

The Settings window provides the following:

- **User Information:** Use to specify your name and phone number.
- **Languages:** Allows you to select the language in which phone prompts and applications appear. Supported languages are English, French, Spanish, German, Dutch, Italian, and Portuguese. Note: The system can support up to three languages at one time. Language choices appearing in the phone display are controlled by ICP programming.
- **Text Size:** Allows you to specify the font size (large or small) for the 5340 IP Phone.
- **Programmable Keys:** Use to assign features to the Programmable Keys that are available in the *Phone* application.
- **Call Notification:** Use to specify that the *Phone* application behaviour when incoming or outgoing calls occur.
- **Brightness and Contrast:** Allows you to adjust the display brightness and contrast of your phone.
- **Screen Saver:** Allows you to specify a specific time of inactivity on your phone that triggers the screen saver to display.
- **Audio Feedback:** This setting allows you to adjust the volume of the audio feedback as well as the error beeps and enable or disable the setting.
- **External Message:** Allows you to program your phone to launch the *Phone* application when it displays special messages in the Information Display area.
- **Go To URL:** Allows you to enable third party URLs to display in the *Web Browser* application.
- **PC Connectivity:** Allows you to enter a password that is used by the phone to establish communications with the PC-resident 5330/5340 Companion application.
- **About 5330/5340 IP Phone:** This screen displays the software release.

Getting Help

To access the 5330/5340 IP Phone help and documentation:

1. Launch the *Applications*.
2. Press **Help**. You have the following options:
 - Press **Launch PC Help** to display www.edocs.mitel.com.
 - Press **Key Icons**.
 - Press the < and > keys to view **Quick Help** items.
3. Press **Close**.

Tips for Setting up your Phone

After you receive your 5330/5340 IP Phone, use the options in the *Settings* application to customize your phone. After customizing your phone, select *Applications* to verify the settings are correct. Now, you are ready to begin using your phone.

CUSTOMIZING YOUR PHONE

Use the *Settings* application to customize your phone.

Note: The System Administrator can invoke a Lock to Factory default option on a per-phone basis. When this is in effect, the following settings are set by the system administrator and you cannot change them:

- Programmable Keys
- External Messaging
- Go to URL

Specify User Information

To specify the phone number displayed on your phone:

1. Press **Settings** or .
2. Press **User Information**.
3. Press **Edit Name**.
4. In the on-screen keyboard, press the appropriate letters to spell your name.
5. Press **Save**.
6. Press **Edit Number**.
7. In the on-screen keyboard, press the appropriate numbers for your line.
8. Press **Save**.
9. Press **Save** again.

Note: Press **Cancel** at any time to exit this application without making any changes or press **Clear** to clear the entered name and number.

Specify Language

To specify the language in which prompts and applications display:

1. Press **Settings** or .

2. Press the **Language** setting.

The phone displays the three language selections that are currently programmed in the ICP.

3. Select the appropriate language and press **Save**.

The phone displays your chosen language.

Note: Languages supported on the 5330/5340 may differ from those supported on the ICP. If the phone is configured for an unsupported language, the prompts may appear in your selected language but the Application language for the phone defaults to English. The Language window displays "(name of the selected language)(Unsupported)".

Specify Display Brightness and Contrast

You can adjust the brightness and display contrast either via the phone volume controls (when the phone is idle) or via the *Settings* application. (On a 5330 IP Phone, you can only adjust the contrast, not the brightness.)

To adjust the display contrast using the volume controls:

- Repeatedly press  (**UP**) or  (**DOWN**).

Note: You can use this method only when the phone is idle. If the phone is ringing, this action adjusts the ring volume. If the phone is in use, this action adjusts the handset, headset and speakerphone volume.

To adjust the display brightness and contrast using the *Settings* application:

1. Press **Settings** or .

2. Press **Brightness and Contrast**.

3. Press the Brightness and Contrast keys to adjust the brightness and contrast of your screen.

4. Press **Save**.

Note: Press **Cancel** at any time to exit this application without making any changes.

Specify Audio Feedback Options

The error beep volume in the phone is related to the volume of the speaker. You can set the beep volume using this procedure; however, adjusting the speaker volume also affects the beep volume.

To adjust the volume of the audio feedback:

1. Press **Settings** or .
2. Press **Audio Feedback**.
3. Set the options using the appropriate actions described below:

Option	Action
Turn audio feedback off for errors	Press Turn Off .
Adjust audio for error beeps	Press Volume + or Volume –
Turn audio feedback on for errors	Press Play Error Tone

4. Click **Save**.

Note: Press **Cancel** at any time to exit this application without making any changes.

Specify Text Size

To specify the text size that displays on the phone:

1. Press **Settings** or .
2. Press **Text Size**.
3. Select **Large Text** or **Small Text**.
4. Press **Save**.

Note: This setting is available only on the 5340 since the 5330 always uses large text. Large is the default text size on the 5340 IP Phone.

Specify Call Notification Behavior

To specify that the *Phone* window automatically displays when you are making or receiving calls:



1. Press **Settings** or .
2. Press **Call Notification**.
3. Press the appropriate options to identify when you want the *Phone* window to display. For example, if you select the *Made* option, each time the phone goes off hook to make a call, the *Phone* window is displayed.
4. Press **Save**.

Notes:

- When *To my prime line* is selected, select *Display Call Info* to display Call Information instead of the *Phone* window.
- Press **Cancel** at any time to exit this application without making any changes.
- When the *Conference Unit* application is displayed, the *Phone* application is not automatically displayed when making or receiving calls.

Adjust the Ringer

To adjust the Ringer Volume while the phone is idle:

1. Press **Superkey** (must be programmed to a key).
2. Press the **No** softkey until "Ringer Adjust?" appears.
3. Press "Ring Adjust".
4. Press **No**.
5. Press "Ringer Vol".
6. Press  (UP) or  (DOWN) .
7. Press **Superkey**.



To adjust the Ringer Volume while the phone is ringing:

- Press  (UP) or  (DOWN).

Notes:

- If the phone is in talk state, this action adjusts the volume of the handset, headset or speaker.
- If the phone is idle, this action adjusts the contrast.

To adjust the Ringer Pitch while the phone is idle:

1. Press **Superkey** (must be programmed to a key).
2. Press the **No** softkey until "Ringer Adjust?" appears.
3. Press "Ring Adjust".
4. Press "Ringer Pitch".
5. Press  (UP) or  (DOWN).
6. Press **Superkey**.

Enable a Screen Saver (5340 only)

You can program your screen saver to turn on after a specific time period of inactivity on your phone.

To enable a screen saver:

1. Press **Settings** or .
2. Press **Screen Saver**.
3. Select the inactivity time, which will activate the backlight switch to turn off.
4. Press the checkbox opposite **Display image** if you wish the screen saver to be displayed. If you do not press this checkbox, only the set backlight is turned on.
5. Use the **Brightness** options to adjust the Brightness of the screen saver , if necessary.
6. Press **Save**.

Program Receipt of External Messaging

You can program your phone to launch the *Phone* application when it receives messages (other than phone calls).

To program receipt of External message types:

1. Press **Settings** or .
2. Press **External Messages**.
3. Press the checkbox **Enable**.
4. Press **Save**.

Enable URL Displays on your Phone

To enable third-party URLs to display in the *Web Browser* application:

1. Press **Settings** or .
2. Press **Go to URL**.
3. Press the checkbox **Enable**.
4. Press **Save**.

Enable PC Connectivity

To enable a connection to be set up between your phone and the PC Companion Application:

1. Press **Settings** or .
2. Press **PC Connectivity**.
3. Press the checkbox **Enable**.
4. Press **Save**.

For more information on setting up the PC Companion Application, [Configuring the PC Companion on Your Phone](#).

USING THE PC COMPANION APPLICATION

About the PC Companion Application

The PC Companion Application is a PC-based desktop programming tool that allows you to easily program your phone keys and label those keys using your PC. You can also use the PC Companion Application to program your feature keys to launch phone or PC applications, open PC documents like a Microsoft Word document, or navigate to a URL directly using your browser.

Configuring the PC Companion Application on Your Phone

Use this procedure to connect your phone to the PC. This procedure is normally required only once. When your PC and phone have successfully associated the first time, your settings are saved and reused for each subsequent connection.

1. Press **Settings** or , then select **PC Connectivity**.

The phone's IP Address appears on the display:

IP Address for PC: AAA.BBB.CCC.DDD

2. Record the IP address, if desired, or repeat Step 1 when you need to view the IP address.
3. Still in the PC Connectivity window, select **Enable**.
4. Select **Edit password** and enter the password that will be used to set up the association with the PC application. You can also choose to use the default password. Record this password as you will need it to configure the PC application.
5. Proceed to *Installing the PC Companion Application* below.

Installing the PC Companion Application

Use this procedure to install the PC Companion Application software.

1. Determine the installation directory from which to install the PC Companion Application. For example, this may be a CD-ROM or a network directory. Contact your System Administrator if you have any questions.
2. Shut down all other applications before installing the PC Companion Application.
3. From the installation directory, double-click Setup.exe.
4. If there is a previous installation of the PC Companion Application on your PC, the installer indicates that you should remove it first. Use the **Add or Remove Programs** in Control Panel, and scroll to **Mitel 5330 5340 PC Companion Application**, select it, and click on Remove. When this is completed, double click Setup.exe again.
5. Follow the instructions in the installation program.

6. To launch the PC Companion Application, click the Windows Start menu and navigate to **Mitel -> Mitel 5330 5340 PC Companion Application**.
7. In the PC Companion application, do the following:
 - a) Select PC Connectivity from the menu on the left.
 - b) Enter the IP Address field you recorded in Step 2 [in Configuring the PC Companion on Your Phone](#).
 - c) Enter the password you selected in Step 4 in [Configuring the PC Companion on Your Phone](#) or use the default password.
8. Click **Connect**.



The PC Companion Application connects with the 5330/5340 IP phone.

Notes:

- The PC Companion application is started every time you log in or your PC is restarted.
- If your PC Companion Application is not connecting to your phone (for example, if your programmed feature Keys are disabled or you receive an error message upon start-up), contact your administrator.
- To ensure that the PC Companion Application displays properly, verify that your screen meets the minimum VGA screen requirements documented in the Installation Guide.

Opening the PC Companion Application

You can open the PC Companion Application in one of the following ways:

- Double-click the Tool tray icon () or desktop shortcut icon ().
- Select your Windows **Start** menu, select **Programs**, then **Mitel**, then **PC Companion Application**.
- From your phone's default Phone window, press **Applications**, then press **Launch PC Application**.
- Press the **PC App** programmed feature key (if available) from your phone's default Phone window.

Programming Feature Keys Using the PC Companion Application

1. Select **Programmable Keys** from the menu, and then click the desired key.
2. Program a phone feature, phone applications, or PC application:

To program a Phone Feature:

- Select **Telephone Feature** from the **Feature** list.
- Select the desired feature and then enter the required information in the fields provided.

To program a Phone Application:

- Select the application from the **Feature** list.

To program a PC Application:

- Select the desired PC application from the **Feature** list and then enter the required information in the fields provided.

3. Click **Save**.

Notes:

- To program a Call Forwarding feature key, you must use the *Call Forwarding* application. See [Call Forward](#) for programming instructions.
- In the **Programmable Keys** dialog, select **Clear this Key** if you make a mistake or if you wish to start over (that is, clear all entered data) when programming a key.
- If your administrator has programmed the keys using an external program, then you may not be able to modify the key programming. If the **Clear** option is not available on the pop-up menu when you right-click a key, or if the **Save** button is disabled in the Programmable Keys dialog, contact your administrator to see if you have the option to program your keys.
- To ensure that the Open URL feature key launches in a new window (instead of launching in an already open window), you may need to configure your Internet browser settings not to reuse open browser windows. For example, in Microsoft Internet Explorer, you select **Tools** followed by **Internet Options**, click the **Advanced** tab, and then ensure that the **Reuse windows for launching shortcuts** option is not selected. Refer to your browser help files for detailed procedures.

Clearing, Editing or Copying Key Programming

1. Select **Programmable Keys** from the menu.
2. Right-click the key you want to clear, edit, or copy.
3. Do one of the following:
 - Select **Clear**. Re-program the key, if desired.
 - Select **Edit...**, reprogram the key as desired, and then click **Save**.
 - Select **Copy**, right-click the key you wish to paste programming information to, and then select **Paste**.

Note: You must enter a new label when changing key programming. If you do not enter a new label, the **Label** field displays the label that applied to the previous programmed key.

PROGRAMING FEATURES ON YOUR KEYS

Tips on Programming Features

You can program your phone's programmable keys to enable features. To program your keys, use:

- *Settings* application.
- **Settings** key .
- PC Companion application.

You can assign the following to a programmable Key:

- Features and Fixed function keys: see [Program Feature Keys Using the Setting Application](#).
- Applications: *People, Settings, Call Forwarding, Conference Unit* (see [Program Phone Application](#))

Notes:

- Use the *Settings* application whenever possible to program keys. Do not use the programmable **Superkey** to program Programmable Keys that can be programmed through the *Settings* applications.
- Only the System Administrator can program line select and line appearance keys. The user's Prime line by default is Key 1.

Features available for programming on programmable keys

Feature	Default Label
Speed Call	Speed Call
Music	Music
Night Answer	Night Ans
Account Code Verified	Acct Verified
Account Code Non-Verified	Acct Non-Ver
Hot Desking	Hot Desk
Phonebook	Phonebook
Speak@Ease™	Speak@Ease
ACD	ACD

Feature	Default Label
Auto Answer	Auto Ans
Paging	Paging
Call Pickup	Call Pickup
Call Back	Call Back
Headset	Headset
Make Busy	Make Busy
Campon	Campon
Override	Override
Direct Page	Page
Do Not Disturb	DND
Single Flash	Flash
Double Flash	Dbf Flash
Meet Me Answer	Meet Me
Message Waiting Indicator	Msg Waiting
Emergency Call	Emergency
Tag Call	Tag Call
Privacy Release	Privacy Rls
Swap	Swap
Release	Release
Call History	Call Hist
Call Park	Call Park
Call Park Retrieve	Park Retrieve
Group Listen	Grp Listen
Superkey	Superkey
Redial	Redial
Speaker	Speaker

Feature	Default Label
Message	Message
Hold	Hold
Transfer/Conference	Trans/Conf
Cancel	Cancel
Analog Line	Analog Line

Applications available for programming on programmable keys

Application	Default Label
Applications List	Applications
People	People
Call Forwarding	Forwarding
Conference Unit	Conf Unit
Launch PC Application	PC App
Help	Help
Settings	Settings
Call Info	Call Info

Program Feature Keys Using the Settings Application

To program a Phone Feature or hard key:

1. Press **Settings** or .
2. Press **Programmable Keys**.
3. Press the key you wish to program.
4. Press **View Features**.
5. Use the Page Navigation keys to move through the features list.
6. Select the desired feature or fixed function key from the list. A default label is automatically assigned to the key.
7. Enter the required information in the fields provided, if necessary.
8. If you are programming any feature other than Message Waiting Indicator and Call Park and Call Park Retrieve, press **Save** and you are finished with this procedure. If you are programming Message Waiting Indicator and or Call Park, perform the following steps:
 - Press the **Edit Number** field.
 - In the on-screen keyboard, enter the appropriate numbers that correspond to the phone whose messages you wish to be notified of. (Message Waiting) or the directory number (Call Park).
 - Press **Save**.
9. Press **Close**.

To program a *Phone* Application:

1. Press **Settings** or .
2. Press **Programmable Keys**.
3. Press the key you wish to program.
4. Press **View Applications**.
5. Select the desired application.
6. Press **Save**.
7. Press **Close**.

To program Speed Call:

1. Press **Settings** or .
2. Press **Programmable Keys**.
3. Press the key you wish to program. If it's already programmed, press **Clear Key**.
4. Press **Speed Call**.
5. Press **Edit Label** and enter the label for the Speed Call.
6. Press **Save**.
7. Press **Edit Number** and enter the phone number for the Speed Call:
 - The maximum length is 26 characters.
 - 0-9, # and *. Pause and Flash are not allowed.
 - The hard dialpad cannot be used to enter the number.
8. Press **Save**, and then press **Save** again.
9. Press **Close**.

Notes:

- To return to the Feature or Applications list at any time, press **Cancel** or the **Applications** key.
- You can also choose to Edit the Label, Clear Information, and Clear Key.

Clear Programming from a Key

You may wish to clear the programming from a key if you are no longer using it.

To clear the feature or application programming from a key:

1. Press **Settings** or .
2. Press **Programmable Keys**.
3. Press the key you wish to clear.
4. Press **Clear Key**.

Either press **Cancel** or reprogram the key.

SETTING UP YOUR CONTACT LIST (5340 ONLY)

Use the *People* application to set up your contact list.

Adding names to your contact list

You can add a name to your contact list by entering it directly using the *People* application or by copying a number from the Call Info window. Since a contact's phone number is mandatory and its name is optional, you are prompted to enter the number first.

To add a name to your contact list using the *People* application:

1. Open the *People* application.
2. Press **New**.
3. Enter the number.
4. Press **Save**. The First Name window appears.
5. Press the appropriate letters to spell the first name of your contact.
6. Press **Save**.
7. Press **Close**.

Editing information in your contact list

1. Open the *People* application.
2. Press the name you wish to edit.
Note: If you wish to delete the name from your contact list, press **Delete**.
3. Press **Edit Name**.
4. In the on-screen keyboard, update the appropriate information.
5. Press **Save**.
6. Press **Edit Number**.
7. In the on-screen keyboard, update the appropriate information.
8. Press **Save** followed by **Close**.

MAKING AND ANSWERING CALLS

You can make a call using one of the following methods:

- Dial a number from the *People* application (for the 5340 IP Phone only).
- Press the programmed key associated with the party you want to call. For more information about programming keys, see [Programming Features On Your Keys](#).
- Dial the number using the dialpad.
- Use **Phone Book** (see [Phone Book](#) below).

Dial from your People Application (5340 IP Phone only)

To dial a contact from your People list:

1. Open the *People* application.
2. Use the navigation keys to page through the contact list and select the name.
3. Dial the contact name using one of the following methods:
 - Select a contact name and press **Dial**.
 - Press the key to the right of the contact's dial icon in the main list. (The contact name does not need to be selected.)
4. Continue the call using the speakerphone or lift the handset.

Phone Book

To use Phone Book:

1. Press **Phone Book** (if available) or the key programmed as **Phone Book**.
2. Enter the name of the desired party, as follows:
 - For each letter in the name, press the appropriate key on the keypad until the letter is shown in the display. For example, if the letter C is required, press the digit 2 three times.
 - Use the <— softkey to correct errors.
 - If the next letter in the name is on the same digit key as the previous letter, press the —> softkey before proceeding.
 - If required, press —> softkey to add a space between the first and last name.
3. Press the **Lookup** softkey.
4. If no match exists, edit the original entry.

5. If more than one match is found, press the **Next** softkey.
6. Do one of the following:
 - To make the call, press the **Call** softkey.
 - To edit the entry, press the **Backup** softkey.
 - To exit, press **Cancel** or **Superkey**.



Answer a call

Do one of the following:

- Select the programmable line key for the ringing line that is flashing.
- Lift the handset or press  (**SPEAKER**).

End a call

Do one of the following:

- Press **Hang Up** or **Cancel** (.
- Replace the handset.
- Press the key that you have programmed as Cancel.
- If you are in Handsfree mode, press  (**SPEAKER**).

Redial

To redial the last number that you manually dialed:

1. Lift the handset (optional).
2. Press  (**REDIAL**).

Redial - Saved Number

To save the last number that you manually dialed:

1. Lift the handset.
2. Dial the appropriate feature access code.

To Redial a saved number:

1. Lift the handset.
2. Dial the appropriate feature access code.

Handsfree Operation

To use Handsfree to make a call:

1. If you want to use a Non-Prime Line, press a Line Appearance key.

Note: Your administrator must program Line Appearances to your phone.

2. Dial the number.
3. Begin speaking when the called party answers. Your phone's Handsfree microphone and Handsfree speaker transmit and receive audio.

To use Handsfree operation to answer calls:

1. Press the flashing line key.
2. Begin speaking. Your phone's Handsfree microphone and Handsfree speaker transmit and receive audio.

To hang up while using Handsfree operation:

- Press  (**SPEAKER**).

To turn Mute on during Handsfree operation:

- Press  (**MUTE**). The Mute key light turns ON.

To turn Mute off and return to conversation:

- Press  (**MUTE**). The Mute key light turns OFF.

To disable Handsfree operation:

- Lift the handset.

To return to Handsfree operation:

1. Press  (**SPEAKER**).
2. Hang up the handset.

Auto-Answer

When the Auto-Answer feature is active, incoming calls ring briefly, and then the phone answers the call in Handsfree mode. You can continue the call handsfree or use the handset.

To enable or disable Auto-Answer:

- Press **Auto-Answer** key. (See [Programming Features on Your Keys](#) for instructions on programming features on your phone.) The key is highlighted and all incoming calls are answered in Handsfree mode.

To switch from Handsfree mode to handset mode:

1. Lift the handset

To end a call, do one of the following:

- Press  (**Cancel**)
- Press the **Hang Up** softkey.
- Wait for the caller to hang up.

Using the Analog line

The phone can support the Line Interface Module. See *Using the Line Interface Module* for more information.

CALL HANDLING

Hold

To place a call on Hold:

- Press  (**HOLD**).
- Press the key that you have programmed as Hold. The indicator flashes on the line that has the held call.

Note: You can only retrieve a call from hold when the phone is idle.

To retrieve a call from Hold, do one of the following:

- Lift the handset and press the flashing line.
- Press the flashing indicator.
- Use the Add Held feature to conference into the held call.

To retrieve a call from Hold at another phone, do one of the following:

- Press the flashing line key.
- Dial the appropriate feature access code and the number of the station that placed the call on Hold.

Mute

Mute lets you temporarily turn your phone's handset, headset or handsfree microphone off during a call.

To turn Mute on during a call:

- Press  (**MUTE**). The  (**MUTE**) light turns ON.

To turn Mute off and return to the conversation:



- Press  (**MUTE**). The  (**MUTE**) light turns OFF.

Note: If you are on a Handsfree MUTED call and you lift the handset, the handset microphone is automatically enabled and the MUTE light turns OFF.

NOTE FOR USERS ON RESILIENT 3300 ICP SYSTEMS: If your phone switches to the secondary system while your speaker or handset is muted (that is, while the Mute key is lit) the call remains muted until you hang up.

Transfer

To Transfer an active call:



1. Press  (TRANSFER).
2. Dial the number of the third party.
3. Do one of the following:
 - To complete the Transfer, hang up.
 - To announce the Transfer, wait for an answer, consult, and hang up.
 - To cancel the Transfer, press  (CANCEL).

To transfer an active call during headset operation:

1. Press  (TRANSFER).
2. Dial the number of the third party.
3. To complete the Transfer, press the Release feature key.

Conference

To form a Conference when a two-party call is already in place, or to add another party to an existing Conference:

1. Press  (TRANSFER).
2. Dial the number of the next party.
3. Wait for an answer.
4. Press  (TRANSFER).

To leave a Conference:

- Hang up or press  (CANCEL).

Conference Split

To Split a Conference and speak privately with the original party:

- Press the **Split** softkey.

Add Held

To move a call on hold to another line appearance:

1. Press an available line key.
2. Press the **AddHeld** softkey.
3. Press the flashing line key.

To add a call on Hold to an existing conversation or conference:

1. Press the **AddHeld** softkey.
2. Press the flashing line key.

Swap

To call another party when you are in an established two-party call:

1. Press  (TRANS/CONF).
2. Dial the number.

To alternate between the two parties:

- Press the **Trade Calls** softkey.

Call Forwarding

Call Forward lets you redirect incoming calls to an alternate number when your phone is busy, when you're not answering, or all the time.

PROGRAM CALL FORWARD

You can create Call Forward profiles that identify where to send your incoming calls. Once you create and save a Call Forward profile, in the [Call Forwarding](#) application, you can enable or disable it at any time.

Notes:

- The None Profile is a default profile provided by the system. It has no numbers programmed and is used to turn off Call Forwarding.
- The default profile appears when the Call Forwarding set up does not match any of your profiles.
- Only one call profile can be active at a time.
- The dotted radio button icon next to the profile shows the current active profile.

To create a Call Forward profile:

1. Launch *Applications*.
2. Press **Call Forwarding**.
3. Press **New Profile**.
4. Press **Edit Profile Name**. An on-screen keyboard displays.
5. Press the appropriate keys in the on-screen keyboard to enter the profile name and press **Save**. This profile name identifies where your phone calls will be forwarded to.
6. Select the check boxes opposite Call Forward categories as follows:
 - **Always**: forwards all your phone calls
 - **Busy Internal**: forwards internal phone calls after several rings if your line is busy
 - **Busy External**: forwards external phone calls after several rings if your line is busy
 - **No Answer Int**: forwards internal phone calls redirects your calls after several rings if you don't answer
 - **No Answer Ext**: forwards external phone calls redirects your calls after several rings if you don't answer

Note: You can select one or more settings, however, the Always setting takes priority over all other settings.

7. For each of the Call Forward categories:
 - Press **Edit Number** to display the on-screen keyboard.
 - In the on-screen keyboard, enter the appropriate number.
 - Press **Save**.
8. Press **Save**. The edit window closes. This profile is saved but it is not activated. To activate this profile, see *Activate Call Forward* below.

Note: Press **Cancel** at any time to exit this application without making any changes.

ACTIVATE CALL FORWARD

To turn Call Forward on once it has been programmed:

1. Press *Applications*.
2. Press **Call Forwarding**.
3. Press the appropriate Profile setting.
4. Press **Activate**.

CANCEL CALL FORWARD

To cancel Call Forward:

1. Press *Applications*.
2. Press **Call Forwarding**.
3. Press **None** setting.
4. Press **Activate**.

USING OTHER FEATURES

Account Codes

An account code is a series of digits that you assign to your calls, usually for accounting purposes. The code identifies the account in the call records that your system generates. A forced account code is usually entered from another extension, enabling you to use features or make calls that the extension otherwise could not. If you want this feature enabled on your phone, ask your System Administrator.

To use Account Codes:

1. Lift the handset.
2. Dial the Account Code digits.
3. Press #.

To enter an Account Code during a call:

1. Press **Superkey** (must be programmed to a key).
2. Select **Account Code**.
3. Dial the Account Code digits.
4. Press the **Save** softkey.
5. Do one of the following:
 - For a verified account code, press the **Yes** key.
 - For a non-verified account code, press the **No** key.

ACD

If your phone is ACD-enabled, you can log in as an agent. When there is no agent logged onto an ACD-enabled set, *LOGGED OUT* is displayed.

To log in as an ACD agent:

1. Lift the handset.
2. Press **Superkey**.
3. Press **Yes**.
4. Enter your Agent ID, using the key pad.
5. Press **Enter**.

The text, *LOGGED OUT* disappears.

Attendant Call Hold - Remote Retrieve

To retrieve a call placed on Hold by the attendant:

1. Lift the handset.
2. Dial the appropriate feature access code.
3. Dial the digits announced by the attendant.

Callback

The Callback feature allows you to be notified when a busy phone becomes free or when a phone has been used after a no-answer condition was encountered.

To request a Callback when you reach a busy or unanswered station:

1. Press **Call Me Back**.
2. Hang up.

When the party is available, your phone starts ringing, and the display shows the Callback ringing indicator.

To answer a Callback:

- When you see the Callback ringing indicator, lift the handset.

Call Forward - Remote (I'm Here)

To forward calls from a remote station to your current location:

1. Press **SuperKey** (must be programmed to a key).
2. Press the **No** softkey until "Call Forwarding?" appears.
3. Press the **Forwarding** softkey.
4. Press the **Next** softkey until "I Am Here" appears.
5. Press the **To Me** softkey.
6. Dial the extension of the remote station.

If you make an error while dialing, use the <— softkey to backspace and correct the number.

7. Press  (**DOWN**) or the **Save** softkey.

To cancel Call Forward – Remote from the station that set the remote forwarding:

1. Lift the handset.
2. Dial the appropriate feature access code.
3. Dial the extension of the remote station.
4. Hang up.

To cancel Call Forward – Remote from the station that was forwarded:

1. Press **SuperKey** (must be programmed to a key).
2. Press the **No** softkey until "Call Forwarding?" appears.
3. Press the **Forwarding** softkey.
4. Press the **Review** softkey.
5. Press the **Change Key** softkey.
6. Press the **Turn FWD Off** softkey.
7. Press **SuperKey** (must be programmed to a key).

Call Forward - End Chaining

To ensure that calls do not get forwarded again by the destination number:

1. Lift the handset.
2. Dial 64.
3. Hang up.

To again allow calls to be forwarded by the destination number:

1. Lift the handset.
2. Dial the appropriate feature access code.
3. Hang up.

Call Forward - Forced

To force an incoming call to be forwarded:

- Press the Forward softkey.

Call Forward - Override



To override Call Forward and ring a station:



1. Lift the handset.
2. Dial the appropriate feature access code.
3. Dial the extension number.

Call History

Call History keeps track of the names (if available) and telephone numbers of missed calls, answered incoming external calls, and outgoing external calls. Once enabled on your phone by your system administrator, it functions automatically.

To display the call history, and view call detail:

1. Press the **Call History** feature key. The total number of missed calls is displayed in brackets (), the number of new missed calls is indicated with a *.
2. To browse through the list of missed calls, press the **Yes** softkey, followed by the  (UP) and  (DOWN) keys to scroll through the list.

To view answered or outgoing calls, press the **No** softkey (once for Answered, twice for Outgoing), followed by the  (UP) and  (DOWN) keys to scroll through the list.

3. To view the number of the call, press the **Details** softkey.

To return a call:

1. Display the call you want to return.
2. Do one of the following:
 - If the call is internal, and the caller name is known, press the **Call** softkey. For unknown numbers, the **Call** option is not displayed.
 - If the call is external, and you normally need to precede external calls with a digit such as 9, it is likely that your system administrator has programmed your system to insert the 9 for you. In this case, pressing the **Call** softkey initiates the call immediately. Sometimes the system will be unable to complete the dialing automatically. When this happens, you can edit the dialed digits manually by pressing the <— (**Clear**) softkey. Use the <— (**Clear**) softkey to delete the left-most digit, and then type the digits to insert them. When you have the dial string edited to suit your needs, press the **Call** softkey to dial the number.

To delete all missed, answered, or outgoing call logs:

1. After selecting the type of logs you wish to delete, press the **Delete All** softkey.
2. Confirm that you do want to delete all items by pressing the **Yes** softkey.

To delete a particular call from the call log:

- With the call log that you want to delete displayed, press **Yes** twice or press the **Delete** softkey.

Call Park

The Call Park feature allows you to place a call in a special hold state. You, or someone else, can then retrieve the call from any extension in the system.

After parking the call, the system can automatically connect you to paging equipment so that you can announce the call to the requested party.

To park an active call:

1. Do one of the following:
 - Press the **Call Park** feature key (must be programmed)
 - Press  (TRANS/CONF), and then dial the appropriate feature access code. The display shows PARKED@, followed by the park destination and parking spot index (if applicable). Example: PARKED@ 1234 @ 02.
2. Dial the directory number on which to park the call (not required if the number is programmed to the **Call Park** feature key).
3. To inform a user that a parked call is waiting, do one of the following:
 - If automatic paging is enabled, announce the call and the park retrieve digits shown on the display.
 - If automatic paging is disabled, press the programmed **Page** key, or dial the appropriate feature access code, followed by the Paging zone number (if required). Then, announce the call and park retrieve digits shown on the display.

Note: Paging over a loudspeaker is not permitted in handsfree mode; you must use the handset or headset.

To retrieve a parked call:

1. Do one of the following:
 - Dial the appropriate feature access code.
 - Press the **Call Park - Retrieve** feature key (must be programmed).
2. Dial the directory number on which the call is parked (not required if the number is programmed to the **Call Park** feature key).
3. If there are multiple calls parked on the number, dial the two-digit index number to retrieve a specific call, or # to retrieve the longest parked call.

Call Pickup

To answer a call that is ringing at another extension in your Pickup Group:

1. Lift the handset.
2. Press the key that you programmed as **Pickup**.

To answer a call that is ringing at another extension not in your Pickup Group:

1. Lift the handset.
2. Dial the appropriate feature access code.
3. Dial the number of the ringing station.

Campon

When you get a busy tone, you can use the Campon feature to be notified when the busy party becomes available.

To Campon to a busy station:

- Press the **I Will Wait** softkey.

To retrieve a call when you hear the Campon tone:

- You can use the Trade Call or Call Swap feature with the  (TRANS/CONF) hardkey or a programmable line key.

Direct Paging

Direct Paging allows you to page a party through the party's handsfree speaker. If the paged party has Off-Hook Voice Announce enabled, the page will be heard even when the party is on a handset or headset call. If the paged party has Handsfree Answerback enabled and turned on on the phone, your page automatically establishes a handsfree call with the paged party.

To page a party:

1. Lift the handset.
2. Press the Direct Paging feature key or dial the appropriate feature access code.
3. Dial the extension number.
4. Speak to the dialed party after the tone.

How you answer a Direct Page depends on whether Handsfree Answerback is enabled and turned on at your phone. See one of the following procedures in this guide:

- Direct Paging - Handsfree Answerback Enabled
- Direct Paging - Handsfree Answerback Disabled

Direct Paging - Handsfree Answerback Enabled

When you receive a Direct Page, Handsfree Answerback automatically establishes a Handsfree call on your phone after a single burst of tone.

Your administrator enables or disables Handsfree Answerback on your phone. After your administrator enables Handsfree Answerback, you can choose to turn it on or off directly from your phone.

To turn Handsfree Answerback on:

- When your phone is idle, press  (MUTE) once. The MUTE key light flashes to indicate that Handsfree Answerback is ON.
- When a Direct Page arrives, the MUTE key light turns OFF and a Handsfree call is automatically established.

To turn Handsfree Answerback off:

- Press the flashing  (MUTE) key once. The MUTE key light turns OFF.
- To respond to a Direct Page when Handsfree Answerback is OFF, see "Direct Page - Handsfree Answerback Disabled" elsewhere in this guide.

Note: By default, Handsfree Answerback is turned OFF at your phone. If the  (MUTE) key is OFF when your set is idle, Handsfree Answerback is OFF.

To answer a call using Handsfree Answerback:

Phone state before Page arrives	To answer the Direct Page
Phone is idle and MUTE is flashing	<ol style="list-style-type: none">1. Check that MUTE is OFF.2. Listen for the paging party.3. Begin speaking.4. Lift the handset if you wish to switch from a Handsfree call to a handset call.
You are on a handset or headset call, and MUTE is OFF	<ol style="list-style-type: none">1. Check that MUTE is flashing.2. Press MUTE. The light turns ON solid, and you are now speaking to the paging party and have muted your handset/headset call.3. Speak to the paging party. Press MUTE to alternate between handset/headset and handsfree calls.
You are on a MUTED handset/headset call, OR, you are on a Handsfree call	The party paging you receives a busy tone. Handsfree Answerback does not interrupt your call.

To end a Handsfree Answerback call:

- Press either  (**SPEAKER**) or  (**CANCEL**).

When the Handsfree Direct Page call ends, the MUTE key light returns to the state it was in before the call was established.

Direct Paging - Handsfree Answerback Disabled

Your administrator enables or disables Handsfree Answerback and you can also turn it on or off on your phone. To turn Handsfree Answerback off, see "Direct Paging - Handsfree Answerback Enabled" elsewhere in this guide. When Handsfree Answerback is disabled on your phone and you receive a Direct Page, the Direct Page is indicated by a single burst of tone.

To answer Direct Page calls when Handsfree Answerback is disabled:

Phone state before Page arrives: To answer the Direct Page (indicated by single burst of tone):

Phone is idle and MUTE is OFF.

1. Check that MUTE is ON solid.
2. Lift the handset **OR** press MUTE key to answer in Handsfree mode. (The light turns OFF.)
3. Begin speaking.



You are on a handset call or headset call, and MUTE is OFF

1. Check that MUTE is flashing.
2. Press MUTE. The light turns ON solid and you are now speaking to the paging party and have MUTED your handset/headset call.
3. Speak to the paging party. Press MUTE to alternate between handset and handsfree calls.

You are on a MUTED handset/headset call, OR, you are on a Handsfree call

The party paging you receives a busy tone. Handsfree Answerback does not interrupt your call.

To end a Direct Page call, do one of the following:

- Hang up the handset to end a handset call.
- Press  (**SPEAKER**) to end a Handsfree call.
- Press  (**CANCEL**).

When the Handsfree Direct Page call ends, the (MUTE) key light returns to the state it was in before the call was established.

Do Not Disturb

When you enable Do Not Disturb, callers will get a busy tone, and an on-screen text message indicating that you do not wish to be disturbed.

To activate or deactivate Do Not Disturb:

- Press the Do Not Disturb key that you programmed. The key is highlighted when Do Not Disturb is activated and is not highlighted when Do Not Disturb is not activated. The phone status line shows the Do Not Disturb  icon.

To activate Do Not Disturb from a remote extension:

1. Lift handset.
2. Dial the number of the station to which **Do Not Disturb** is to apply.
3. Hang up.

To deactivate Do Not Disturb from a remote station:

1. Lift handset.
2. Dial the appropriate feature access code.
3. Dial the number of the station with **Do Not Disturb** activated.
4. Hang up.

Emergency Calls

Warning for emergency number dialing: Consult your local authorities for Emergency Numbers and 911 or equivalent service availability in your area.

There are two methods of dialing emergency numbers, based on the programming of your 3300 ICP:

- Emergency Call Routing NOT programmed
- Emergency Call Routing programmed

Caution: Verify with your System Administrator which type of emergency number dialing you can use.

EMERGENCY CALLS WHEN EMERGENCY CALL ROUTING NOT PROGRAMMED

If Emergency Call Routing is NOT programmed, Emergency Number dialing should only be performed by picking up the handset and selecting the Analog Line key you have programmed. If Privacy Mode is enabled and the Analog Line key local line is busy, dialing will not occur on the Line Interface Module line. Emergency dialing using an IP connection may not be supported due to ICP system configuration and country location. For more information, contact your System Administrator.

To make an Emergency Call using the Line Interface Module line:

1. Lift the handset.
2. Press the Analog Line key that you have programmed.

The set indicates *ANALOG CALL*

3. Dial your Local Emergency Number.

To make an Emergency Call using the Line Interface Module line, when the IP connection has failed:

1. Lift the handset.
2. Press the Analog Line key that you have programmed.

The set indicates *IP FAIL: ANALOG CALL*.

3. Dial your Local Emergency Number.

EMERGENCY CALLS WHEN EMERGENCY CALL ROUTING PROGRAMMED

Note: This procedure is in addition to the methods described above.

To make an Emergency Call if Emergency Call Routing is programmed:

1. Lift the handset.
2. Dial your Local Emergency Number (911 or equivalent).

For more information on using the Line Interface Module line, refer to Using the Line Interface Module.

Group Listen

With Group Listen, you can carry on a conversation using the handset or headset while allowing others nearby to listen to the person at the far end over the handsfree speaker. The handsfree microphone is disabled in Group Listen mode.

To activate Group Listen while in a handset conversation:

- Press the **Group Listen** key.

Audio from the far-end party is now heard through both the handset/headset and the speaker.

To make the call a normal two-way speaker call:

- Press  (**SPEAKER**).

To exit Group Listen mode (and return to a normal handset/headset call):

- Press the **Group Listen** key.

To activate or deactivate Group Listen while in headset mode:

- Press the **Group Listen** key.

Group Paging / Meet Me Answer

Group Paging allows you to page a group of telephones through their built-in speakers. You can belong to as many as three paging groups with one group designated as your "prime" group.

When you need to respond to a Group Page but don't know the identity or extension number of the paging party, use the Meet Me Answer feature. You have up to 15 minutes after receiving the page to use Meet Me Answer.

To make a Group Page:

1. Lift the handset.
2. Press **Direct Page** or dial the appropriate feature access code.
3. Do one of the following:
 - To page your prime page group, press #.
 - To page a specific page group, dial the page group directory number.
4. Speak to the dialed party after the tone.

+To respond to a Group Page by using Meet Me Answer:

1. Lift handset.
2. Press the key you have programmed to Meet Me Answer or dial the appropriate feature access code.

(See [Programming Features on Your Phone](#) for instructions on programming features to your phone.)

3. Do one of the following:
 - To respond to a page from your prime page group, press #.
 - To respond to a page from a specific page group, dial the page group directory number.

Headset Operation

To enable Headset Operation:

- Press the **Headset** feature key.

To answer a call (when Auto Answer is disabled):

- Press the flashing line key.

To answer call (when Call Notification is enabled)

- Select **Close** and then select the prime line.

To hang up:

- Press  (CANCEL).

To mute your headset microphone:

- Press the  (MUTE) key. The light turns ON.

To turn mute off and return to the conversation:

- Press the  (MUTE) key. The light turns OFF.

Hot Desking

Hot Desking allows you to log into the telephone system from any phone designated as a Hot Desk phone. When you log in at the phone using your assigned Hot Desk User Extension Number, the phone assumes all your speed dials, features keys, call forwarding setup, and line appearances - even your language preference for the display. Any changes you make to the phone while you are logged in--for example, adding a speed dial--are saved to your personal profile. Logging in activates your profile on any phone that supports Hot Desking.

When you log in as a hot desk user, Call History data is updated for you. You do not see any call logs for the phones registered DN; you only see your history data. When you log out, the registered DN's history data is displayed. To access your voice mail when you are logged in as a hot desk user, you must log in to your voice mail.

To log into a Hot Desking phone (the phone must be idle):

1. Press the key you have programmed to **HotDesking**.
2. Press the **Login** key.
3. Using the phone keys, enter your Hot Desk User Extension Number, and then press **OK**.
4. Enter your pin number and press **OK**.

While logged in as a hot desk user, the phone status line shows the Hot Desk  icon.

To log out of Hot Desking phone (the phone must be idle):

1. Press the key you have programmed to **HotDesking**.
2. Press the **Logout** command key.
3. Press the **Confirm** command key.

Note: Your profile can only be active on one phone at a time. If you log in from another phone without logging out from the first one, the system will automatically deactivate your profile on the first phone.

Hot Desk Remote Logout

A user who has forgotten to log out of a Hot Desking phone can be logged out from a phone that is configured to allow Hot Desk Remote Logout.

Note: This feature must be allowed by your System Administrator via the Class of Service.

To remotely log out a Hot Desking phone:

1. Dial 111.
2. Dial the Hot Desk User Extension Number that you want to log out.

3. Press the **Logout** command key.
4. Press the **Confirm** command key.

Hot Desk - PIN Change

To change your Hot Desk PIN:

1. Log into a Hot Desking phone.
2. Press **Superkey** (must be programmed to a key).
3. Press the **HotDesk PIN** softkey.
4. Press the **Yes** softkey.
5. Enter the current PIN or skip to step 6 if a PIN has not yet been assigned.
6. Press the **Enter** softkey.
7. Enter the new PIN.
The PIN can include digits from 0 to 9 only and can be from 0 to 8 characters in length.
8. Press the **Enter** softkey.
9. Re-enter the new PIN.
10. Press **Superkey**.

Make Busy

You can use the Make Busy feature to have your phone appear busy to other callers. If callers dial your phone number when Make Busy is enabled a message indicating that your line is busy is displayed on their phones.

To enable Make Busy:

- Press the key you programmed to **Make Busy**. The key illuminates when Make Busy is activated and *MAKE BUSY* is displayed.

To disable Make Busy:

- Press the key you programmed to **Make Busy**.

Message Waiting Indicator

The Message Waiting Indicator (MWI) feature allows you to be notified when messages have been left on another phone. Once you have programmed a key to MWI, this key is always enabled.

To use MWI to contact the extension that left a message:

- Press the key you have programmed to MWI.

Messaging - Advisory

Advisory Messaging enables you to select a notice that appears on your phone display to inform people visiting your desk of your whereabouts. Select from a variety of advisory messages, including "On vacation", "In a meeting", or "Out to Lunch".

To turn Messaging - Advisory on:

1. Press **Superkey** (must be programmed to a key).
2. If necessary, press the **No** softkey until "Advisory Msgs" appears.
3. Press the **Advisory** softkey.
4. Press the **Next** softkey until the desired message appears.
5. Press the **Turn Msg On** softkey.

To turn Messaging - Advisory off:

1. Press **Superkey** (must be programmed to a key).
2. If necessary, press the **No** softkey until "Advisory Msgs" appears. .
3. Press the **Yes** softkey when "Advisory appears.
4. Press the **Turn Msg Off** softkey .

Messaging - Callback

To leave a Callback Message when you hear busy or ringback tone:

- Press  (**MESSAGE**) or press the **Callback** softkey.

To respond to a message waiting condition on your phone:

1. Press  (**MESSAGE**).
2. If a password is required, dial your password (and press the **Enter** softkey if available).

3. Press the **Read Message** softkey, and do one or all of the following:
 - To display the time the message was sent, press the **More Msg** softkey.
 - To display the number of the caller, press the **More Msg** softkey twice.
 - To call the message sender, press the **Call** softkey.
 - To delete the message, press the **Erase Msg** softkey.
 - To view the next message, press  (**MESSAGE**).

You can check for messages from a remote station:

1. Press Superkey (must be programmed to a key).
2. Press the **No** softkey until "Remote Msging?" appears.
3. Press the **Yes** softkey.
4. Dial your extension number.
5. Press the **Enter** softkey.
6. If a password is required, enter your password and press the **Enter** softkey.
7. Press the **Yes** softkey.

You can set, change, or clear a password (up to 7 digits, not including 0):

1. Press **Superkey** (must be programmed to a key).
2. Press the **No** softkey until "Set Password?" appears.
3. Press the **Yes** softkey.
4. Do one of the following:
 - To enter a new password, enter your password.
 - To change or clear your password, enter your current password.
5. Press the **Enter** softkey.
6. To change or clear your password, do one of the following:
 - To change your password, enter your new password and press the **Enter** softkey.
 - To clear your password, enter 0.
7. Enter your new password again.
8. If you are setting up or changing a password, press the **Enter** softkey.
9. Press **Superkey** (must be programmed to a key).

Messaging - Cancel Callback

To cancel a Callback:

1. Lift the handset.
2. Dial the appropriate feature access code.
3. Dial the number of the called station.
4. Hang up.

Messaging - Cancel All Callbacks

To cancel all Callbacks:

1. Lift the handset.
2. Dial the appropriate feature access code.
3. Hang up.

Music

To turn Music on and off when the phone is idle, do one of the following:

- To turn the music on, press the key that you programmed to Music or the Music softkey.
- To turn the music off, press the key that you programmed to Music or the Music softkey.

When the Music is activated, the key you have programmed is highlighted.

Night Answer

The Night Answer feature allows you to route calls to an attendant or message at night.

To enable Night Answer:

- Press the key you programmed to Night Answer. When you have enabled Night Answer, this key is highlighted.

To disable Night Answer:

- Press the key you programmed to Night Answer

Override (Intrude)

When you dial a number whose owner has enabled Make Busy, your phone displays the message indicating that the line is busy. You have the option to override this setting.

To use Override when you encounter a busy tone:

1. Press the key you programmed as **Override**.
2. Wait for an answer.

Paging

To use Paging:

1. Lift handset.
2. Press the key that you have programmed to **Page**.
3. Dial the Paging zone number (if required).
4. Make the announcement.

Record a Call

This feature uses your voice mail system to record your telephone conversations.

Note: You may be required by law to inform the other party that you are recording the conversation. For specific instructions, consult your system administrator.

To start recording while on a 2-party call:

- Press the **Record Call** key. (See *Feature Keys* elsewhere in this guide for instructions on programming a **Record Call** key to your phone.)

Note: Your system may be programmed to automatically begin recording external calls when you or the other answers.

To control recording, do one or all of the following:

- To pause recording, press the **Pause** softkey.
- To resume recording after pausing, press the **Resume** softkey.
- To stop a recording without saving it, press the **Erase** softkey or  (**CANCEL**).
- To stop and save a recording, press the **Save** softkey.

Putting the call on hold saves the recording; taking the call off hold starts a new recording. Depending on system programming, hanging up, or pressing  (**TRANS/CONF**) or a **DSS** key, may also save the recording.

To listen to a recording:

1. Lift the handset.
2. Access your voice mailbox.
3. Follow the prompts to retrieve the recording.

Reminder

To program a Reminder:

1. Press **Superkey** (must be programmed to a key).
2. Press the **No** softkey until "Timed Reminder" appears.
3. Press the **Reminder** softkey.
4. Enter the time in 24-hour format.
5. Press the **Save** softkey.

To view, change, and/or cancel a pending Reminder:

1. Press **Superkey** (must be programmed to a key).
2. Press the **No** softkey until "Timed Reminder" appears.
3. Press the **Reminder** softkey.
4. Do one of the following:
 - To change the Reminder, press the **Change Key** softkey, enter the new time, and press the **Save** softkey.
 - To cancel the Reminder, press the **Cancel No.** softkey.
 - To exit without canceling the Reminder, press **Superkey** (must be programmed to a key).

To acknowledge a Reminder when your phone rings once:

- Press the **Confirm** softkey.

Speak@Ease

Users of the Speak@Ease softkey can place a call by speaking the name of the person they wish to dial. Speak@Ease enables you to have access to Mitel Speech Server. The Speech Server is a speech recognition application that routes incoming calls to a specific destination based on spoken commands.

To dial a call using Speak@Ease:

1. Press the key you have programmed to Speak@Ease.
2. Speak the name of the person you wish to call.

Speed Call

Speed Call is an application that allows you to dial a specific number with one key press. You must program Speed Call on a Programmable key. For more information on programming this key, see [Program Feature Keys Using the Settings Application](#).

To make a Speed Call:

- Press the key that you have programmed as your Speed Call key.

Tag Call

Tag Call allows you to signal that you are the victim of a threatening or malicious call. Using the tag, your system administrator or Telephone Company can identify the source of the call and provide this information to appropriate personnel or authorities.

CAUTION: Tagging a non-malicious call may result in fines or other penalties.

To tag a malicious call:

1. Press the programmed Tag Call key while the call is in progress. For information on how to program keys, see to [Programming Features On Your Keys](#)

-OR-

1. Press  (TRANS/CONF).
2. Dial the appropriate feature access code.

If the call was successfully tagged, *Thank You* is shown on the display; otherwise, *Not Allowed* is displayed.

Note: Tag Call can be used on active two-party calls only. Calls on hold and conference calls cannot be tagged.

Trunk Flash

The Trunk Flash feature allows you to access Centrex features (if available) while you are talking on an outside call.

To flash a trunk while talking on an outside call:

1. Press the key you have programmed to Flash.

Note: You can program a key to single flash or double flash.

2. Wait for dial tone.
3. Dial the Centrex feature access code.

USING YOUR PHONE WITH THE 5310 IP CONFERENCE UNIT

Your phone uses the 5310 IP Conference Unit for conferencing. You use the Conference Controller to turn the conference unit off or on, to adjust the volume or to put the conference unit into Presentation mode. You can only run one Conference Controller session at a time. If the 5310 Conference Unit is not connected to your phone, the *Conference Controller* application is not available.

Access the Conference Controller

To access the Conference Controller:

1. Press **Applications** and press **Conference Unit**, or
2. Press the key programmed to the *Conference Unit* application.

Turn the conference unit on and off

1. Verify that the conference unit is connected to your phone.
2. Access the Conference Controller. For more information, see [Access Conference Controller](#).
3. Press **Turn On/Turn Off**.

While the Conference Unit is on, the  icon shows in the phone status line.

Adjust the conference unit volume

- Press Volume Up or Volume Down.

Place the conference unit in Presentation mode

Presentation Mode is used when only one individual is speaking to a group. If another member in the group wishes to speak, you must disable Presentation Mode. Presentation Mode minimizes extraneous noise.

To place the conference unit in Presentation mode

- Press Presentation Mode.

Exit the conference controller

To exit the conference controller

- Press **Close**.

Mute the conference unit

To mute the conference unit so that conversation in the meeting room cannot be heard by individuals being conferenced:

- Press **Mute**.

USING THE LINE INTERFACE MODULE

Your phone supports the Mitel Line Interface Module. The Line Interface Module allows you to make and receive calls over an analog line (Line Interface Module line) connected to your phone. The Line Interface Module operates in either of the following two modes, as determined by your System Administrator:

- **Line Interface Module Mode:** your phone allows you to use the Line Interface Module line at any time
- **Failover Mode:** you can use the Line Interface Module line only when the IP connection has failed

Note: Handsfree and on-hook dialing are not supported on the Line Interface Module line.

For information on emergency number dialing using the Line Interface Module, refer to Emergency Calls.

Making and Answering Calls Using the Analog key

To make a call using the Analog line:

1. Lift the handset.
2. Press the key you programmed as **Analog Line**.
ANALOG CALL is displayed.
3. Dial the number.

Note: When you make an external call over the analog line, a prefix dialing number is not required. If your phone's Analog Line key has the Privacy option enabled, you cannot access the analog line when another phone is using the analog line (key is solid orange). To access the analog line, the user of the other phone must first hang up. To determine whether the Privacy option is enabled, contact your System Administrator.

To answer a Call using the analog line:

1. Lift the handset.
2. Press the **Analog Line** key that is highlighted.

To answer a waiting call on the analog line:

Note: If you have subscribed to an analog call waiting service, you may use the hookswitch or press **Cancel** (⊗) to answer a waiting analog call. When you are on an analog call and a waiting analog call arrives, you hear a beep. This feature may not be supported in all regions.

To answer a waiting analog call or return to the original analog call:

1. Do one of the following:
 - Press and release the hookswitch
 - Press **Cancel** (⊗)
2. Press the key you have programmed as **Analog Line**.

To put a current call on hold to answer an incoming analog call:

- Press the highlighted **Analog Line** key.

To switch between the current call and the held call when one of the calls is using the analog line, do one of the following:

- If your current call is using the analog line, press the flashing Line key of the held call. The analog call is automatically put on hold.
- If your current call is using an IP line, press the highlighted Analog Line key. The IP line is automatically put on hold.

To end a current call when an incoming analog call arrives:

- Press **Cancel** (⊗) and then press the highlighted Analog Line key. The current call ends and you are connected to the caller on the analog line.

To end the current analog call when an incoming call arrives:

- Press **Cancel** (⊗). The current analog call ends and you are connected to the new caller.

Making and Answering Calls Using the Failover Mode

To make a call using the analog line during an IP connection failure:

1. Lift the handset.

The phone displays *IP FAIL: ANALOG CALL*.
2. Dial the number.

To answer a call using the analog line during an IP connection failure:

- Lift the handset. The call is answered. The phone displays *IP FAIL: ANALOG CALL*.

